

**A Dimensions: [mm]**

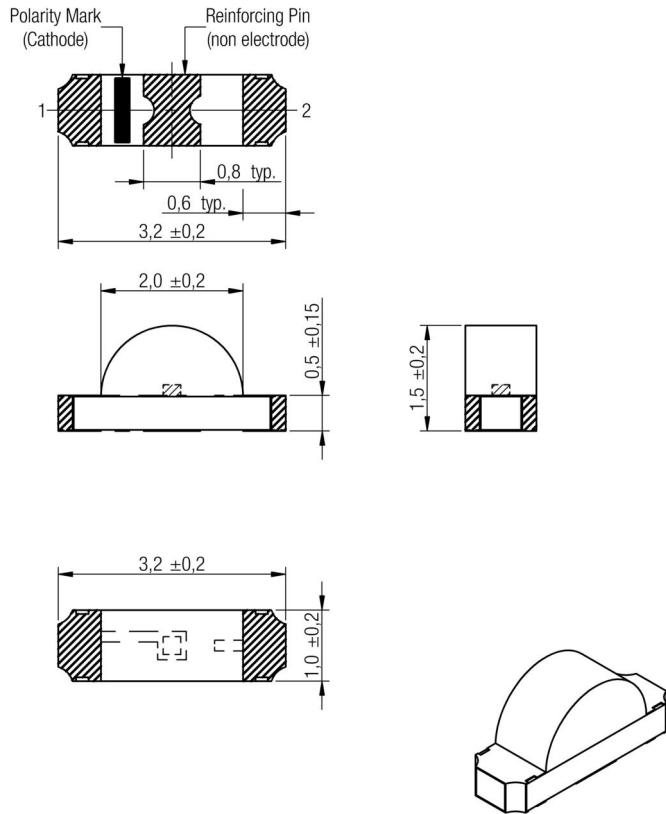

**B Recommended land pattern: [mm]**

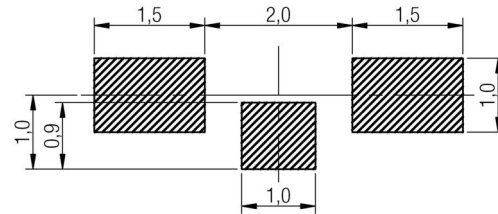

Scale - 10:1

**C Schematic:**

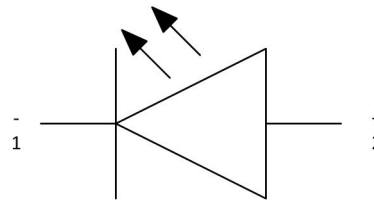

Scale - 10:1



**D Absolute Maximum Ratings (Ambient Temperature 25°C):**

Properties	Test conditions		Value	Unit
Power dissipation		$P_{Diss}$	60	mW
Peak Forward Current	duty/10@1kHz	$I_F Peak$	100	mA
Continuous Forward Current		$I_F$	25	mA
Reverse Voltage		$V_{Rev}$	5	V
ESD Threshold/ Human Body Modell		$V_{ESD HBM}$	2000	V

**E General information:**

- Operating temperature: -40°C to +85°C
- Storage temperature (on tape & reel): -40°C to +85°C; 60% RH max.
- Moisture Sensitivity Level (MSL): 3

**Optical Properties:**

Properties	Value
Chip Technology	AlInGaP
Emitting Color	Red
Lens Type	Round

REV	DATE	BY	CHECKED
1.9	2015-03-23	SSt	HOe
1.8	2014-03-17	SSt	SSt
1.7	2013-12-09	SSt	HOe
1.6	2013-10-08	SSt	HOe
1.5	2013-09-23	SSt	HOe
1.4	2013-04-10	SSt	SSt
1.3	2013-04-11	SSt	SSt

Projection

Würth Elektronik eiSos GmbH & Co. KG  
EMC & Inductive Solutions  
Max-Eyth-Str. 1  
74638 Waldenburg  
Germany  
Tel. +49 (0) 79 42 945 - 0  
www.we-online.com  
eiSos@we-online.com

DESCRIPTION

**WL-SMSW SMD chip LED side view mono-color waterclear**

Order.- No. **155124RS73200**

Size: 1204

COMPLIANT  
**RoHS&REACH**  
HALOGENFREE

SIZE  
A4



**D Electrical & Optical Properties:**

Properties	Test conditions		Value			Unit
			min.	typ.	max.	
<b>Peak Wavelength</b>	20 mA	$\lambda_{Peak}$		632		nm
<b>Dominant wavelength</b>	20 mA	$\lambda_{Dom}$		624		nm
<b>Luminous Intensity</b>	20 mA	$I_V$	90	130		mcd
<b>Forward Voltage</b>	20 mA	$V_F$		2.0	2.4	V
<b>Spectral Bandwidth</b>	20 mA	$\Delta\lambda$		15		nm
<b>Reverse Current</b>	5 V	$I_{Rev}$			10	$\mu A$
<b>Viewing Angle</b>	20 mA	$2\theta_{50\%}$		120		°

				Projection			DESCRIPTION		
1.9	2015-03-23	SSt	HOe	Würth Elektronik eiSos GmbH & Co. KG EMC & Inductive Solutions Max-Eyth-Str. 1 74638 Waldenburg Germany Tel. +49 (0) 79 42 945 - 0 www.we-online.com eiSos@we-online.com			<b>WL-SMSW SMD chip LED side view mono-color waterclear</b>		
1.8	2014-03-17	SSt	SSt						
1.7	2013-12-09	SSt	HOe						
1.6	2013-10-08	SSt	HOe						
1.5	2013-09-23	SSt	HOe						
1.4	2013-04-10	SSt	SSt						
1.3	2013-04-11	SSt	SSt						
REV	DATE	BY	CHECKED						
								Order.- No.	SIZE
							<b>155124RS73200</b>		A4
							Size: 1204		

This electronic component has been designed and developed for usage in general electronic equipment only. This product is not authorized for use in equipment where a higher safety standard and reliability standard is especially required or where a failure of the product is reasonably expected to cause severe personal injury or death, unless the parties have executed an agreement specifically governing such use. Moreover Würth Elektronik eiSos GmbH & Co KG products are neither designed nor intended for use in areas such as military, aerospace, aviation, nuclear control, submarine, transportation (automotive control, train control, ship control), transportation signal, disaster prevention, medical, public information network etc.. Würth Elektronik eiSos GmbH & Co KG must be informed about the intent of such usage before the design-in stage. In addition, sufficient reliability evaluation checks for safety must be performed on every electronic component which is used in electrical circuits that require high safety and reliability functions or performance.



**F1 Viewing Angle:**

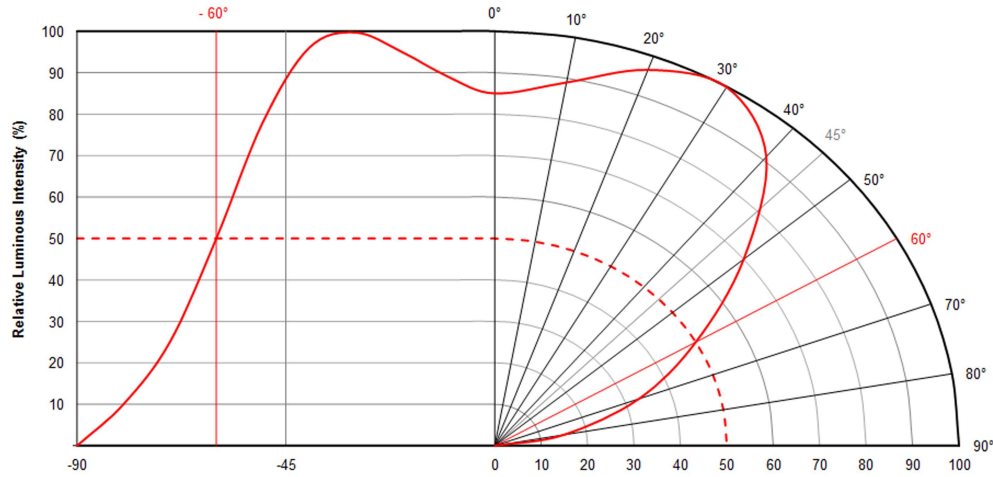

**F2 Spectral:**

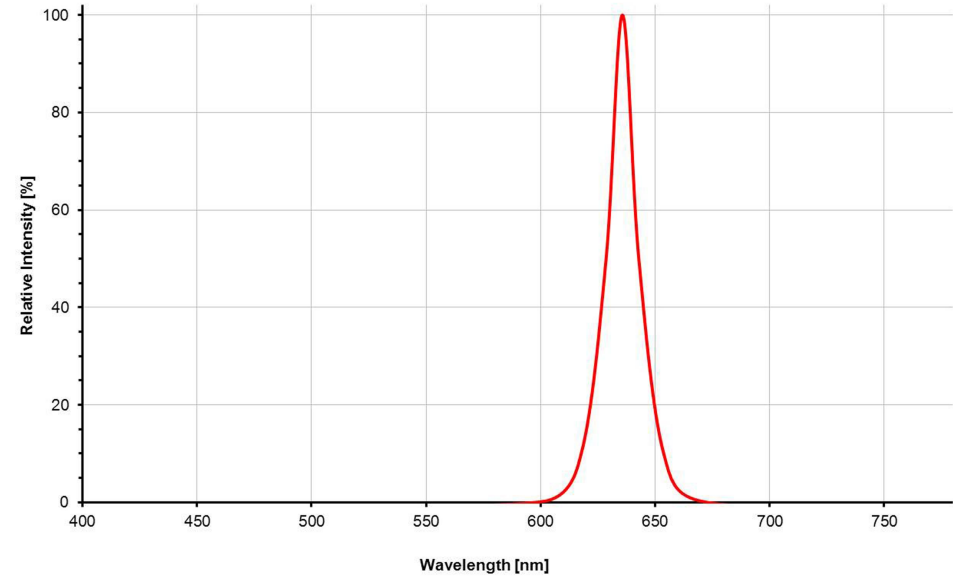

				Projection			DESCRIPTION	
1.9	2015-03-23	SSt	HOe	Würth Elektronik eiSos GmbH & Co. KG EMC & Inductive Solutions Max-Eyth-Str. 1 74638 Waldenburg Germany Tel. +49 (0) 79 42 945 - 0 www.we-online.com eiSos@we-online.com	 COMPLIANT RoHS&REACH HALOGENFREE	<b>WL-SMSW SMD chip LED side view mono-color waterclear</b>	Order.- No.	SIZE
1.8	2014-03-17	SSt	SSt				<b>155124RS73200</b>	A4
1.7	2013-12-09	SSt	HOe					Size: 1204
1.6	2013-10-08	SSt	HOe					
1.5	2013-09-23	SSt	HOe					
1.4	2013-04-10	SSt	SSt					
1.3	2013-04-11	SSt	SSt					
REV	DATE	BY	CHECKED					

This electronic component has been designed and developed for usage in general electronic equipment only. This product is not authorized for use in equipment where a higher safety standard and reliability standard is especially required or where a failure of the product is reasonably expected to cause severe personal injury or death, unless the parties have executed an agreement specifically governing such use. Moreover Würth Elektronik eiSos GmbH & Co KG products are neither designed nor intended for use in areas such as military, aerospace, aviation, nuclear control, submarine, transportation (automotive control, train control, ship control), transportation signal, disaster prevention, medical, public information network etc.. Würth Elektronik eiSos GmbH & Co KG must be informed about the intent of such usage before the design-in stage. In addition, sufficient reliability evaluation checks for safety must be performed on every electronic component which is used in electrical circuits that require high safety and reliability functions or performance.



F3 Forward Current vs. Forward Voltage:

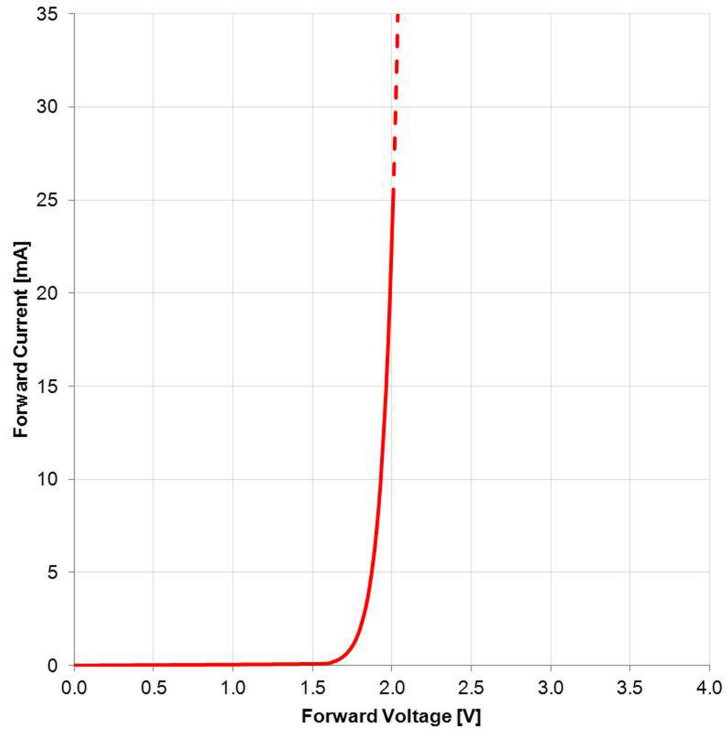

F4 Luminous Intensity vs. Forward Current:

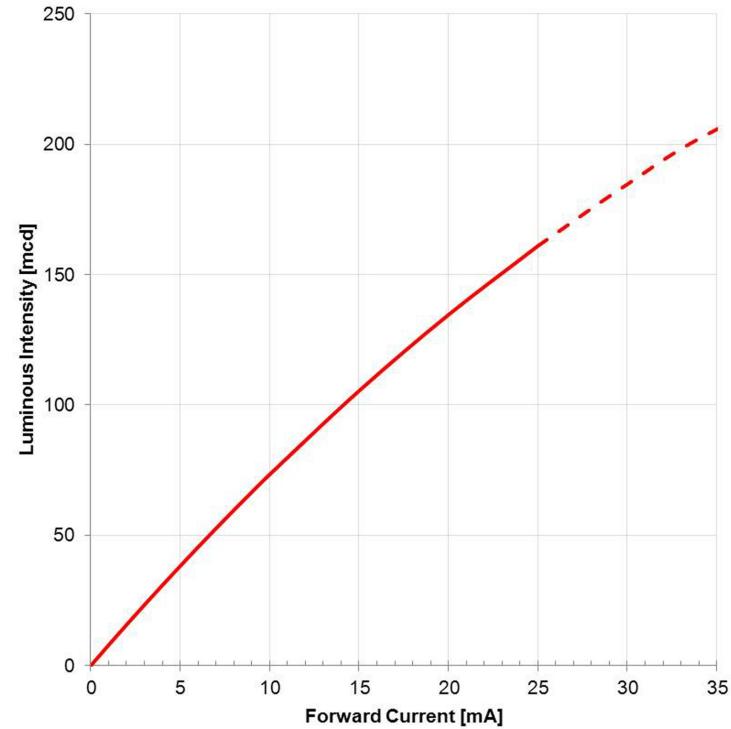

				Projection		DESCRIPTION <b>WL-SMSW SMD chip LED side view mono-color waterclear</b>	
1.9	2015-03-23	SSt	HOe				
1.8	2014-03-17	SSt	SSt	Würth Elektronik eiSos GmbH & Co. KG EMC & Inductive Solutions Max-Eyth-Str. 1 74638 Waldenburg Germany Tel. +49 (0) 79 42 945 - 0 www.we-online.com eiSos@we-online.com	Order.- No.	COMPLIANT RoHS&REACH HALOGENFREE	SIZE
1.7	2013-12-09	SSt	HOe		<b>155124RS73200</b>		A4
1.6	2013-10-08	SSt	HOe		Size: 1204		
1.5	2013-09-23	SSt	HOe				
1.4	2013-04-10	SSt	SSt				
1.3	2013-04-11	SSt	SSt				
REV	DATE	BY	CHECKED				

This electronic component has been designed and developed for usage in general electronic equipment only. This product is not authorized for use in equipment where a higher safety standard and reliability standard is especially required or where a failure of the product is reasonably expected to cause severe personal injury or death, unless the parties have executed an agreement specifically governing such use. Moreover Würth Elektronik eiSos GmbH & Co KG products are neither designed nor intended for use in areas such as military, aerospace, aviation, nuclear control, submarine, transportation (automotive control, train control, ship control), transportation signal, disaster prevention, medical, public information network etc.. Würth Elektronik eiSos GmbH & Co KG must be informed about the intent of such usage before the design-in stage. In addition, sufficient reliability evaluation checks for safety must be performed on every electronic component which is used in electrical circuits that require high safety and reliability functions or performance.



**F5 Derating Curve:**

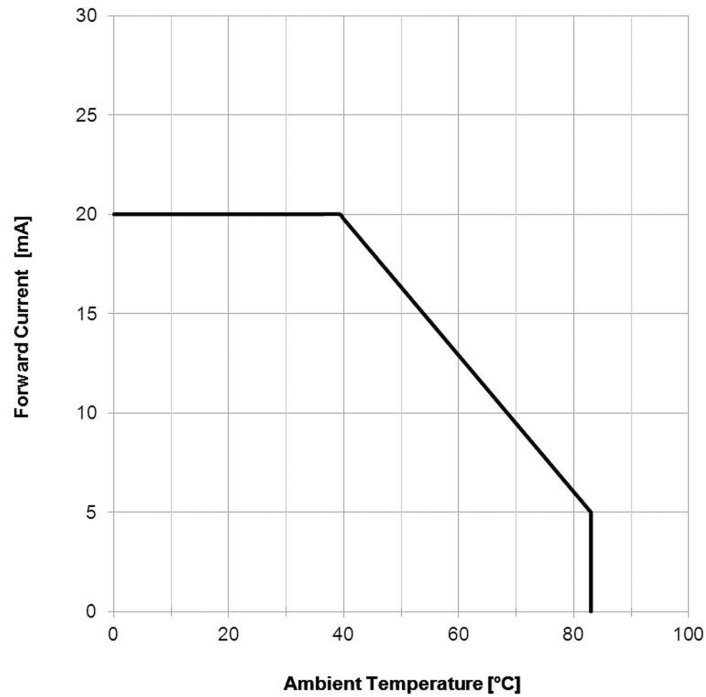

				Projection			DESCRIPTION	
1.9	2015-03-23	SSt	HOe	Würth Elektronik eiSos GmbH & Co. KG EMC & Inductive Solutions Max-Eyth-Str. 1 74638 Waldenburg Germany Tel. +49 (0) 79 42 945 - 0 www.we-online.com eiSos@we-online.com		<b>WL-SMSW SMD chip LED side view mono-color waterclear</b>	Order.- No.	SIZE
1.8	2014-03-17	SSt	SSt				<b>155124RS73200</b>	A4
1.7	2013-12-09	SSt	HOe					Size: 1204
1.6	2013-10-08	SSt	HOe					
1.5	2013-09-23	SSt	HOe					
1.4	2013-04-10	SSt	SSt					
1.3	2013-04-11	SSt	SSt					
REV	DATE	BY	CHECKED					

This electronic component has been designed and developed for usage in general electronic equipment only. This product is not authorized for use in equipment where a higher safety standard and reliability standard is especially required or where a failure of the product is reasonably expected to cause severe personal injury or death, unless the parties have executed an agreement specifically governing such use. Moreover Würth Elektronik eiSos GmbH & Co KG products are neither designed nor intended for use in areas such as military, aerospace, aviation, nuclear control, submarine, transportation (automotive control, train control, ship control), transportation signal, disaster prevention, medical, public information network etc.. Würth Elektronik eiSos GmbH & Co KG must be informed about the intent of such usage before the design-in stage. In addition, sufficient reliability evaluation checks for safety must be performed on every electronic component which is used in electrical circuits that require high safety and reliability functions or performance.

### G Packaging Specification - Tape and Reel [mm]:

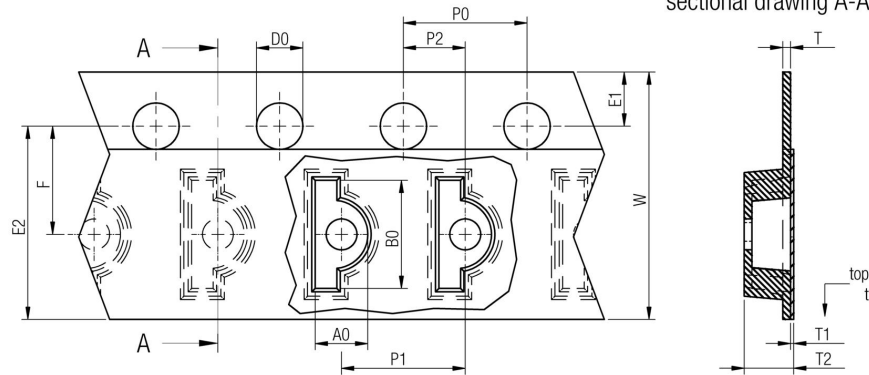

	A0	B0	W	P1	T	T1	T2	D0	E1	E2	F	P0	P2	Tape	Packaging Unit
tolerance	typ.	typ.	+0,3 -0,1	± 0,1	± 0,1	max.	typ.	+0,1 -0,0	± 0,1	min.	± 0,05	± 0,1	± 0,05		
size	<b>1204</b>	1,70	3,50	4,00	0,22	0,10	1,50	1,50	1,75	6,25	3,50	4,00	2,00	Polystyrene	3000

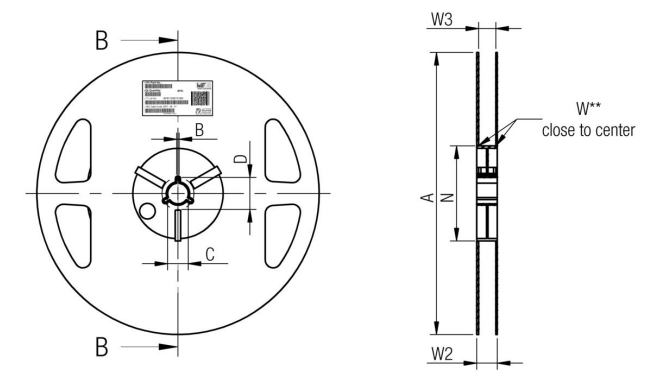

	A	B	C	D	N	W1	W2	W3	W3	
tolerance	± 2,0	min.	± 0,8	min.	min.	+ 1,5	max.	min.	max.	
Tape width	<b>8 mm</b>	178,00	1,50	13,00	20,20	50,00	8,40	14,40	7,90	10,90

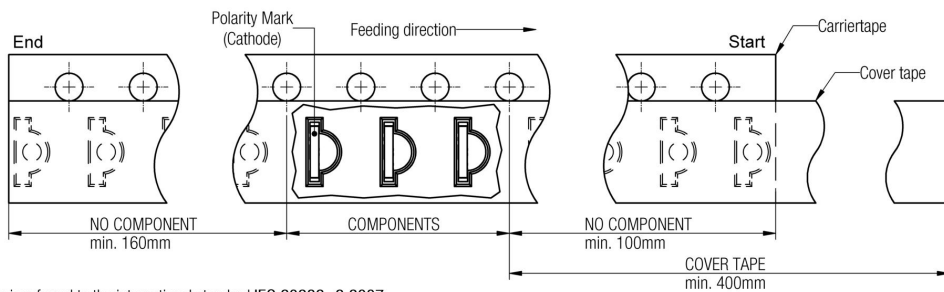

Packaging is referred to the international standard IEC 60286 -3:2007

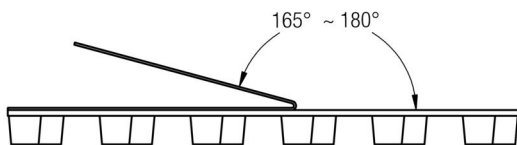
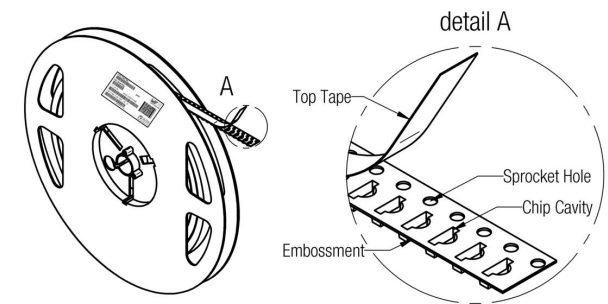

<b>Pull-of force</b>	0,1 N - 1,0 N
<b>Tape width</b>	<b>8 mm</b>

REV	DATE	BY	CHECKED
1.9	2015-03-23	SSt	HOe
1.8	2014-03-17	SSt	SSt
1.7	2013-12-09	SSt	HOe
1.6	2013-10-08	SSt	HOe
1.5	2013-09-23	SSt	HOe
1.4	2013-04-10	SSt	SSt
1.3	2013-04-11	SSt	SSt

Projection

Würth Elektronik eiSos GmbH & Co. KG  
EMC & Inductive Solutions  
Max-Eyth-Str. 1  
74638 Waldenburg  
Germany  
Tel. +49 (0) 79 42 945 - 0  
www.we-online.com  
eiSos@we-online.com

DESCRIPTION

**WL-SMSW SMD chip LED side view mono-color waterclear**

Order.- No. **155124RS73200**

Size: 1204

SIZE  
A4

This electronic component has been designed and developed for usage in general electronic equipment only. This product is not authorized for use in equipment where a higher safety standard and reliability standard is especially required or where a failure of the product is reasonably expected to cause severe personal injury or death, unless the parties have executed an agreement specifically governing such use. Moreover Würth Elektronik eiSos GmbH & Co KG products are neither designed nor intended for use in areas such as military, aerospace, aviation, nuclear control, submarine, transportation (automotive control, train control, ship control), transportation signal, disaster prevention, medical, public information network etc.. Würth Elektronik eiSos GmbH & Co KG must be informed about the intent of such usage before the design-in stage. In addition, sufficient reliability evaluation checks for safety must be performed on every electronic component which is used in electrical circuits that require high safety and reliability functions or performance.

H Soldering Specifications:



H1: Classification Reflow Profile for SMT components:



H2: Classification Reflow Profile:

Profile Feature	Pb-Free Assembly
Preheat - Temperature Min ( $T_{smin}$ ) - Temperature Max ( $T_{smax}$ ) - Time ( $t_s$ ) from ( $T_{smin}$ to $T_{smax}$ )	150°C 200°C 120 seconds max.
Ramp-up rate ( $T_L$ to $T_P$ )	3°C/ second max.
Liquidous temperature ( $T_L$ ) Time ( $t_L$ ) maintained above $T_L$	217°C 60 seconds max.
Peak package body temperature ( $T_P$ )	250°C max.
Time within 5°C of actual peak temperature ( $t_p$ )	10 seconds max.
Ramp-down rate ( $T_P$ to $T_L$ )	6°C/ second max.
Time 25°C to peak temperature	220 seconds max.
Applied cycles	2 cycles max.

REV	DATE	BY	CHECKED
1.9	2015-03-23	SSt	HOe
1.8	2014-03-17	SSt	SSt
1.7	2013-12-09	SSt	HOe
1.6	2013-10-08	SSt	HOe
1.5	2013-09-23	SSt	HOe
1.4	2013-04-10	SSt	SSt
1.3	2013-04-11	SSt	SSt

Projection

Würth Elektronik eiSos GmbH & Co. KG  
EMC & Inductive Solutions  
Max-Eyth-Str. 1  
74638 Waldenburg  
Germany  
Tel. +49 (0) 79 42 945 - 0  
www.we-online.com  
eiSos@we-online.com

DESCRIPTION

**WL-SMSW SMD chip LED side view mono-color waterclear**

Order.- No. **155124RS73200**

Size: 1204

COMPLIANT  
**RoHS&REACH**  
HALOGENFREE

SIZE  
A4

This electronic component has been designed and developed for usage in general electronic equipment only. This product is not authorized for use in equipment where a higher safety standard and reliability standard is especially required or where a failure of the product is reasonably expected to cause severe personal injury or death, unless the parties have executed an agreement specifically governing such use. Moreover Würth Elektronik eiSos GmbH & Co KG products are neither designed nor intended for use in areas such as military, aerospace, aviation, nuclear control, submarine, transportation (automotive control, train control, ship control), transportation signal, disaster prevention, medical, public information network etc.. Würth Elektronik eiSos GmbH & Co KG must be informed about the intent of such usage before the design-in stage. In addition, sufficient reliability evaluation checks for safety must be performed on every electronic component which is used in electrical circuits that require high safety and reliability functions or performance.

## I Cautions and Warnings:

The following conditions apply to all goods within the product series of WL-SMSW of Würth Elektronik eiSos GmbH & Co. KG:

### General:

All recommendations according to the general technical specifications of the data sheet have to be complied with.

The usage and operation of the product within ambient conditions, which probably alloy or harm the component surface, has to be avoided.

If the product is potted in customer applications, the potting material might shrink during and after hardening. The product is exposed to the pressure of the potting material with the effect that the LED body, pins or termination is possibly damaged by this pressure and so the electrical as well as the mechanical characteristics are endangered to be affected. After the potting material is cured, the LED body, pins or termination of the product have to be checked if any reduced electrical or mechanical functions or destructions have occurred.

The responsibility for the applicability of customer specific products and use in a particular customer design is always within the authority of the customer. All technical specifications for standard products do also apply to customer specific products.

Washing varnish agent that is used during the production to clean the customer application might damage or change the characteristics of the LED body, pins or termination. The washing varnish agent could have a negative effect on the long term function of the product.

Direct mechanical impact to the product shall be prevented as the material of the LED body, pins or termination could flake or in the worst case it could break.

The standard deliveries include values in the range and limitation as defined in the Electrical & Optical Properties specified in the datasheet. On each reel, only one bin is sorted and taped. The bin is defined on intensity, chromaticity coordinate or wavelength and forward voltage. In order to ensure highest availability, the reel binning of standard deliveries can vary. A single bin cannot be ordered. Please contact us in advance, if you need a particular bin sorting before placing your order to clarify the lead time, MOQ and pricing.



### Product specific:

Follow all instructions mentioned in the data sheet, especially:

- The soldering profile has to be complied with according to the technical reflow/ or wave soldering specification, otherwise this will void the warranty.
- All products shall be used before the end of the period of 12 months based on the product date code, if not a 100% solderability can't be ensured.
- Violation of the technical product specifications such as exceeding the absolute maximum ratings will void the warranty.
- It is also recommended to return the LEDs to the original moisture proof bag and reseal the moisture proof bag again.
- Certain LED surfaces consist of soft material. Pressure on the top surface has to be handled carefully to prevent negative influence to the function and reliability of the LEDs.
- ESD prevention methods need to be applied for manual handling and processing by machinery.
- Resistors for protection are obligatory.
- Luminaires in operation could harm human vision or skin on a photo-biological level, therefore direct light impact has to be avoided. All products are additionally certified as risk groups 0 to 2 according to DIN EN 62471:2008

				Projection			DESCRIPTION		
1.9	2015-03-23	SSt	HOe				<b>WL-SMSW SMD chip LED side view mono-color waterclear</b>		
1.8	2014-03-17	SSt	SSt						
1.7	2013-12-09	SSt	HOe				Order.- No.  <b>COMPLIANT RoHS&amp;REACH HALOGENFREE</b>	SIZE	
1.6	2013-10-08	SSt	HOe					<b>155124RS73200</b>	A4
1.5	2013-09-23	SSt	HOe						
1.4	2013-04-10	SSt	SSt						
1.3	2013-04-11	SSt	SSt						
REV	DATE	BY	CHECKED				Size: 1204		

This electronic component has been designed and developed for usage in general electronic equipment only. This product is not authorized for use in equipment where a higher safety standard and reliability standard is especially required or where a failure of the product is reasonably expected to cause severe personal injury or death, unless the parties have executed an agreement specifically governing such use. Moreover Würth Elektronik eiSos GmbH & Co KG products are neither designed nor intended for use in areas such as military, aerospace, aviation, nuclear control, submarine, transportation (automotive control, train control, ship control), transportation signal, disaster prevention, medical, public information network etc.. Würth Elektronik eiSos GmbH & Co KG must be informed about the intent of such usage before the design-in stage. In addition, sufficient reliability evaluation checks for safety must be performed on every electronic component which is used in electrical circuits that require high safety and reliability functions or performance.



## J Important Notes:

The following conditions apply to all goods within the product range of Würth Elektronik eiSos GmbH & Co. KG:



### 1. General Customer Responsibility

Some goods within the product range of Würth Elektronik eiSos GmbH & Co. KG contain statements regarding general suitability for certain application areas. These statements about suitability are based on our knowledge and experience of typical requirements concerning the areas, serve as general guidance and cannot be estimated as binding statements about the suitability for a customer application. The responsibility for the applicability and use in a particular customer design is always solely within the authority of the customer. Due to this fact it is up to the customer to evaluate, where appropriate to investigate and decide whether the device with the specific product characteristics described in the product specification is valid and suitable for the respective customer application or not.

### 2. Customer Responsibility related to Specific, in particular Safety-Relevant Applications

It has to be clearly pointed out that the possibility of a malfunction of electronic components or failure before the end of the usual lifetime cannot be completely eliminated in the current state of the art, even if the products are operated within the range of the specifications.

In certain customer applications requiring a very high level of safety and especially in customer applications in which the malfunction or failure of an electronic component could endanger human life or health it must be ensured by most advanced technological aid of suitable design of the customer application that no injury or damage is caused to third parties in the event of malfunction or failure of an electronic component.

Therefore, customer is cautioned to verify that data sheets are current before placing orders. The current data sheets can be downloaded at [www.we-online.com](http://www.we-online.com).

### 3. Best Care and Attention

Any product-specific notes, cautions and warnings must be strictly observed. Any disregard will result in the loss of warranty.

### 4. Customer Support for Product Specifications

Some products within the product range may contain substances which are subject to restrictions in certain jurisdictions in order to serve specific technical requirements. Necessary information is available on request. In this case the field sales engineer or the internal sales person in charge should be contacted who will be happy to support in this matter.

### 5. Product R&D

Due to constant product improvement product specifications may change from time to time. As a standard reporting procedure of the Product Change Notification (PCN) according to the JEDEC-Standard inform about minor and major changes. In case of further queries regarding the PCN, the field sales engineer or the internal sales person in charge should be contacted. The basic responsibility of the customer as per Section 1 and 2 remains unaffected.

### 6. Product Life Cycle

Due to technical progress and economical evaluation we also reserve the right to discontinue production and delivery of products. As a standard reporting procedure of the Product Termination Notification (PTN) according to the JEDEC-Standard we will inform at an early stage about inevitable product discontinuance. According to this we cannot guarantee that all products within our product range will always be available. Therefore it needs to be verified with the field sales engineer or the internal sales person in charge about the current product availability expectancy before or when the product for application design-in disposal is considered. The approach named above does not apply in the case of individual agreements deviating from the foregoing for customer-specific products.

### 7. Property Rights

All the rights for contractual products produced by Würth Elektronik eiSos GmbH & Co. KG on the basis of ideas, development contracts as well as models or templates that are subject to copyright, patent or commercial protection supplied to the customer will remain with Würth Elektronik eiSos GmbH & Co. KG.

Würth Elektronik eiSos GmbH & Co. KG does not warrant or represent that any license, either expressed or implied, is granted under any patent right, copyright, mask work right, or other intellectual property right relating to any combination, application, or process in which Würth Elektronik eiSos GmbH & Co. KG components or services are used.

### 8. General Terms and Conditions

Unless otherwise agreed in individual contracts, all orders are subject to the current version of the "General Terms and Conditions of Würth Elektronik eiSos Group", last version available at [www.we-online.com](http://www.we-online.com).

				Projection 		DESCRIPTION	
1.9	2015-03-23	SSt	HOe			<b>WL-SMSW SMD chip LED side view mono-color waterclear</b>	
1.8	2014-03-17	SSt	SSt				
1.7	2013-12-09	SSt	HOe			Order.- No.	SIZE
1.6	2013-10-08	SSt	HOe			<b>155124RS73200</b>	
1.5	2013-09-23	SSt	HOe				
1.4	2013-04-10	SSt	SSt				
1.3	2013-04-11	SSt	SSt				
REV	DATE	BY	CHECKED			Size: 1204	

Würth Elektronik eiSos GmbH & Co. KG  
EMC & Inductive Solutions  
Max-Eyth-Str. 1  
74638 Waldenburg  
Germany  
Tel. +49 (0) 79 42 945 - 0  
[www.we-online.com](http://www.we-online.com)  
[eiSos@we-online.com](mailto:eiSos@we-online.com)